

DIGITECH PRO
650/850 VA
UNINTERRUPTIBLE POWER SUPPLY
UPS
USER MANUAL



ENGLISH

Product Overview

650 VA / 850 VA

Front View

- 1 Power Switch
- 2 LCD Display

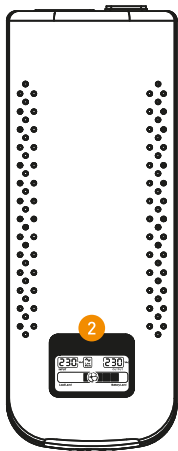
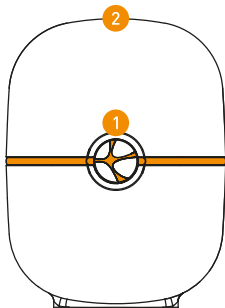

Back View

- 1 AC Input
- 2 USB Communication Port
- 3 RJ 11/45 Protection Port
- 4 Output Receptacles

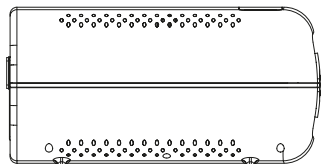
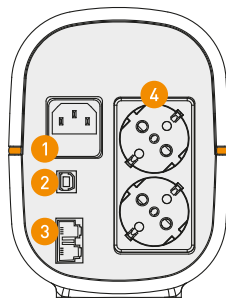

LCD Display

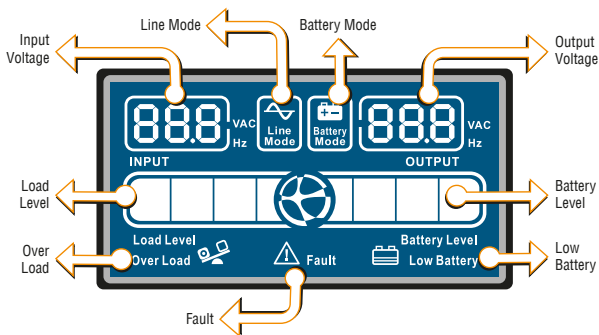

Product Features

Modern, stylish concept

Today the IT users not only want functional products, but also nice looking products which they will enjoy to see every day. Digitech Pro is a unique design and has a display which looks up, if you think 90% of the UPS work under your table on the floor; this makes the user to see the display without bending down.

Multi function LCD display with voltage meter

Digitech Pro has his own way of communicating to it's user; you can see many information from the LCD display like the input/output voltage, load level, battery level, overload etc.

CPU control for reliability

Digitech Pro is a digital UPS which has a high speed CPU ensuring that it does all of it's functions right and on time. This very critical especially for protection of the UPS; as all the overload, overvoltage, undervoltage protections and controlled digitally by the CPU, it provided exceptional reliability to the UPS.

Simulated sine wave

Digitech Pro provides simulated sinewave form which is suitable PC and IT equipment.

Buck and boost AVR function

Digitech Pro acts as a voltage stabilizer as well, if the line voltage is too high it will reduce it to the normal limits or if there is a brownout, Digitech Pro UPS will increase the voltage level to protect it's connected equipment.

USB communication port and software

Digitech Pro comes with a CD and USB cable, you can connect your Digitech Pro UPS to your PC via the USB port. When you load the software to your computer (Windows, Linux or Mac compatible), you can monitor your UPS from your monitor or you can program your UPS on how to function in case of a power failure. Digitech Pro is a smart UPS and can be controlled through your computer or it can make a orderly shutdown by saving all your application data, closing your software and shutting down your operating system and finally shutting down your computer.

Charging when UPS is off

Your UPS can charge it's batteries even when it is not working, you don't have to leave your UPS on order to charge your batteries at night. Your Digitech Pro will safely charge it's batteries even if it's not switched on.

RJ 11/45 (modem/internet) protection port

Digitech Pro is equipped with a special protection port to protect your, telephone line or modem against power surges.

Overload, low and high voltage protection

Digitech Pro provides full reliability by providing several electronic protections to ensure a problem-free long life product. As an example, you can not damage your Digitech Pro by an accidental overloading, it will sense the load and protect itself without any hardware damage.

Low-and high-voltage protection

High capacity battery

Most UPS systems will charge their battery to full in 8 to 10 hours, but Digitech Pro can fill it's batteries in 4 hours to ensure a safe operation in regions where electric failures are very often.

Installation and initial startup

- Before installation, please inspect the unit. Be sure that nothing inside the package is damaged.
- Install the UPS in a protected area that is free of excessive dust and has adequate air flow.
- Do NOT operate the UPS where the temperature and humidity is outside the specific limits. (Please check the technical specs for the limitations)

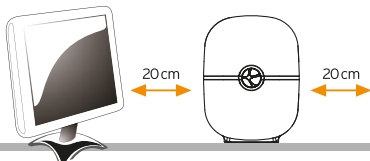

Please place the UPS away from other units at least 20cm to avoid interference.

Connect to utility and charging

Plug in the AC input cord to the wall outlet. The unit charges its battery while connecting to the utility. For the best results, suggest to charge the battery at least 6 hours before initial use.

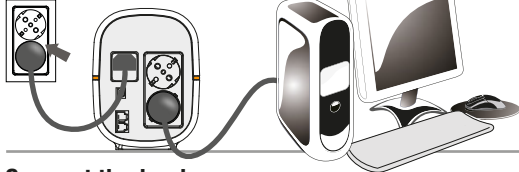

Connect the loads

Plug in the loads to output receptacles on the rear panel of the UPS. Simply turn on the power switch of UPS unit, then devices connected to the UPS will be protected by UPS unit.

Turn On/Off the unit

Turn on the UPS unit by pressing the power switch. Turn off the UPS unit by pressing again the power switch.

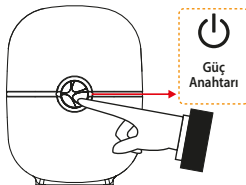

SAFETY - WARNING



This UPS utilizes voltages that may be hazardous. Do not attempt to disassemble the unit. The unit contains no user serviceable parts. Only factory service personnel may perform repairs.

Internal battery voltage is 12Vdc. Sealed, lead-acid, 6 cells battery. Connection to any other type of receptacle other than a two-pole, three-wire grounded receptacle may result in shock hazard as well as violate local electrical codes.

In the event of an emergency, press the Smart On/Off Button for 4 seconds and disconnect the power cord from the AC power supply to properly disable the UPS.

Do not allow liquids or any foreign object to enter the UPS. Do not place beverages or any other liquid-containing vessels on or near the unit.

This unit intended for installation in a controlled environment (temperature controlled, indoor area free of conductive contaminants). Avoid installing the UPS in locations where there is standing or running water, or excessive humidity.

Do not plug the UPS input into its own output.

Do not attach a power strip or surge suppressor to the UPS.

Do not attach to non-computer-related items, such as medical equipment, life-support equipment, microwave ovens, vacuum cleaners, laser printers or washing machine.

To reduce the risk of overheating the UPS, do not cover the UPS cooling vents and avoid exposing the unit to direct sunlight or installing the unit near heat emitting appliances such as space heaters or furnaces.

Unplug the UPS prior to cleaning and do not use liquid or spray detergent.

Do not dispose of batteries in a fire as they may explode.

Do not open or mutilate the battery or batteries.

Released electrolyte is harmful to the skin and eyes. It may be toxic.

Attention, hazardous through electric shock. Also with disconnection of this unit from the mains, hazardous voltage still may be accessible through

supply from battery. The battery supply should be therefore disconnected in the plus and minus pole of the battery when maintenance or service work inside the UPS is necessary.

Servicing of batteries should be performed by authorized personnel. Keep unauthorized personnel away from batteries.

A battery can present a risk of electrical shock and high short circuit current. The following precautions should be observed when working on batteries:

- 1) Remove watches, rings, or other metal objects from the hands.
- 2) Use tools with insulated handles.
- 3) Wear rubber gloves and boots.
- 4) Do not lay tools or metal parts on top of batteries.
- 5) Disconnect charging source prior to connecting or disconnecting batteries terminals.

When replacing batteries, replace with the same number and type of sealed lead-acid battery. The maximum ambient temperature rating is 40°C.

This pluggable type A equipment with battery already installed by the supplier is operable and may be operated by laymen.

During the installation of this equipment it should be assured that the sum of the leakage currents of the UPS and the connected loads does not exceed 3.5 mA.

The mains socket outlet that supplies the UPS shall be installed near the UPS and shall be easily accessible.

TROUBLE SHOOTING

Use the table below to solve minor problems.

Problem	Possible Cause	Solutions
No LED display on the front panel	Low battery	Charge the UPS at least 6 hours
	Battery fault	Replace the battery with the same type of battery (Please see Safety-Warning page)
	The UPS is not turned on	Press the On/Off button at least 1 second to turn on the UPS
Alarm continuously sounds when the mains is normal	The UPS is overload	Remove some loads first. Before reconnecting equipment, please verify that the load matches the UPS capability specified in the specs. (Please see Technical Specification table)
When power fails, back-up time is shorten	The UPS is overload	Remove some critical load
	Battery voltage is too low	Charge the UPS at least 6 hours
	Battery defect. It might be due to high temperature operation environment, or improper operation to battery.	Replace the battery with the same type of battery (Please see Safety-Warning page)
The mains is normal but LED color in red is flashing	Power cord is loose	Reconnect the power cord properly, if the problem can't be solved please consult nearest technical service

TECHNICAL SPECIFICATIONS

CAPACITY	650 VA 360 W	850 VA 480 W
INPUT		
Voltage	220/230/240 VAC	
Voltage range	162-265 VAC	
OUTPUT		
Voltage range	± %10	
Transfer time	2-6 ms, 10 ms max.	
Waveform	Simulated sine wave	
BATTERY		
Type & Number	12V 7Ah x 1	12V 9Ah x 1
Charging time	4-6 hours recover to 90% capacity	
DIMENSIONS AND WEIGHT		
Dimensions D x W x H (mm)	321 x 123,5 x 163,5	
Net weight (kg)	4.15	5.15
ENVIRONMENT		
Humidity	0-40°C 0-90% (non-condensing)	
Noise level	< 40 dBA	